

Suction cups / Silicone

VG.BC40S multi-bellows suction cups in silicone

- Ideal for handling bags containing fragile products and bags with liquids and frozen foods
- Strong bellows, soft and flexible lip and special high flow rate fittings
- Version with 4.5 bellows
- They enable to compensate for level differences



Application example



Technical data						
Material	Lifting force [N] perpendicular to the surface, at various vacuum levels		Volume [cm ³]	Min curve radius [mm]	Max vertical movement [mm]	Suction cup weight [g]
	-20 kPa	-60 kPa				
SIL 40	14.4	15.3	14	22	20	10

Technical features			
Material	Colour	Hardness	Temperature range
Silicone 40	Red	40 Shore	-70 ÷ +200 °C

Identification codes			
Drawing	Alphanumeric code	Suction cups with fitting	Order code
A	VG.BC40S.40.G38M	VG.BC40 suction cup, silicone, 40 Shore, G3/8" male	2322143

A

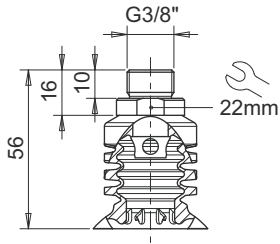

Identification codes			
Drawing	Alphanumeric code	Suction cups	Order code
A	VG.BC40S.40	VG.BC40 suction cup, silicone, 40 Shore	2322144

A

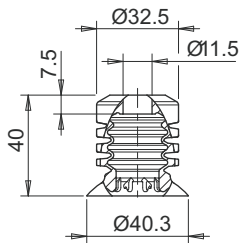

Identification codes			
Drawing	Alphanumeric code	Fittings	Order code
A	FT.G38M.20	G3/8" male fitting	2000038

A

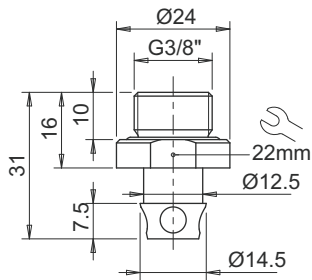

Suction cups / Silicone

VG.BC50S multi-bellows suction cups in silicone

- Ideal for handling bags containing fragile products and bags with liquids and frozen foods
- Strong bellows, soft and flexible lip and special high flow rate fittings
- Version with 4.5 bellows
- They enable to compensate for level differences

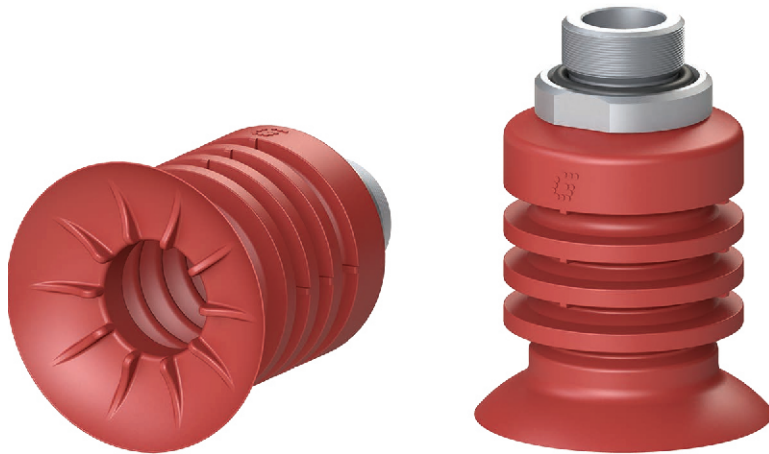

Application example

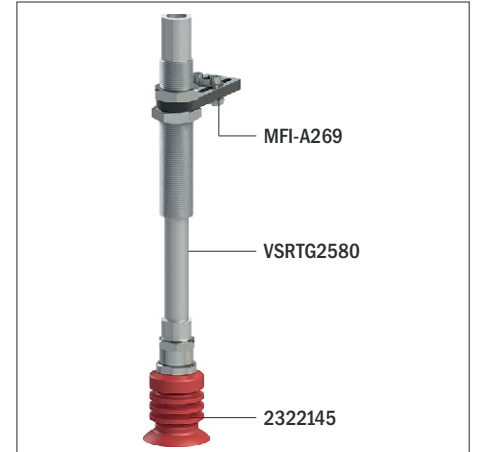

Technical data

Material	Lifting force [N] perpendicular to the surface, at various vacuum levels		Volume [cm ³]	Min curve radius [mm]	Max vertical movement [mm]	Suction cup weight [g]
	-20 kPa	-60 kPa				
SIL 40	26.3	28.2	26	30	18	29

Technical features

Material	Colour	Hardness	Temperature range
Silicone 40	Red	40 Shore	-70 + +200 °C

Identification codes			
Drawing	Alphanumeric code	Suction cups with fitting	Order code
A	VG.BC50S.40.G12M	VG.BC50 suction cup, silicone, 40 Shore, G1/2" male	2322145

A

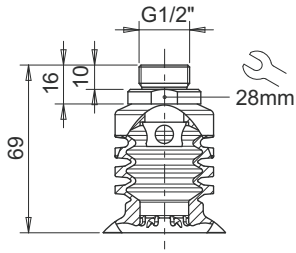

Identification codes			
Drawing	Alphanumeric code	Suction cups	Order code
A	VG.BC50S.40	VG.BC50 suction cup, silicone, 40 Shore	2322146

A

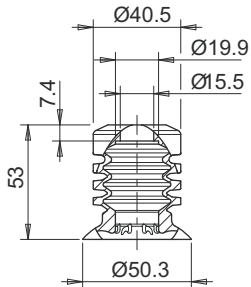

Identification codes			
Drawing	Alphanumeric code	Fittings	Order code
A	FT.G12M.20	G1/2" male fitting	2000012

A

